

gosun[®]
SPORT

USER'S GUIDE

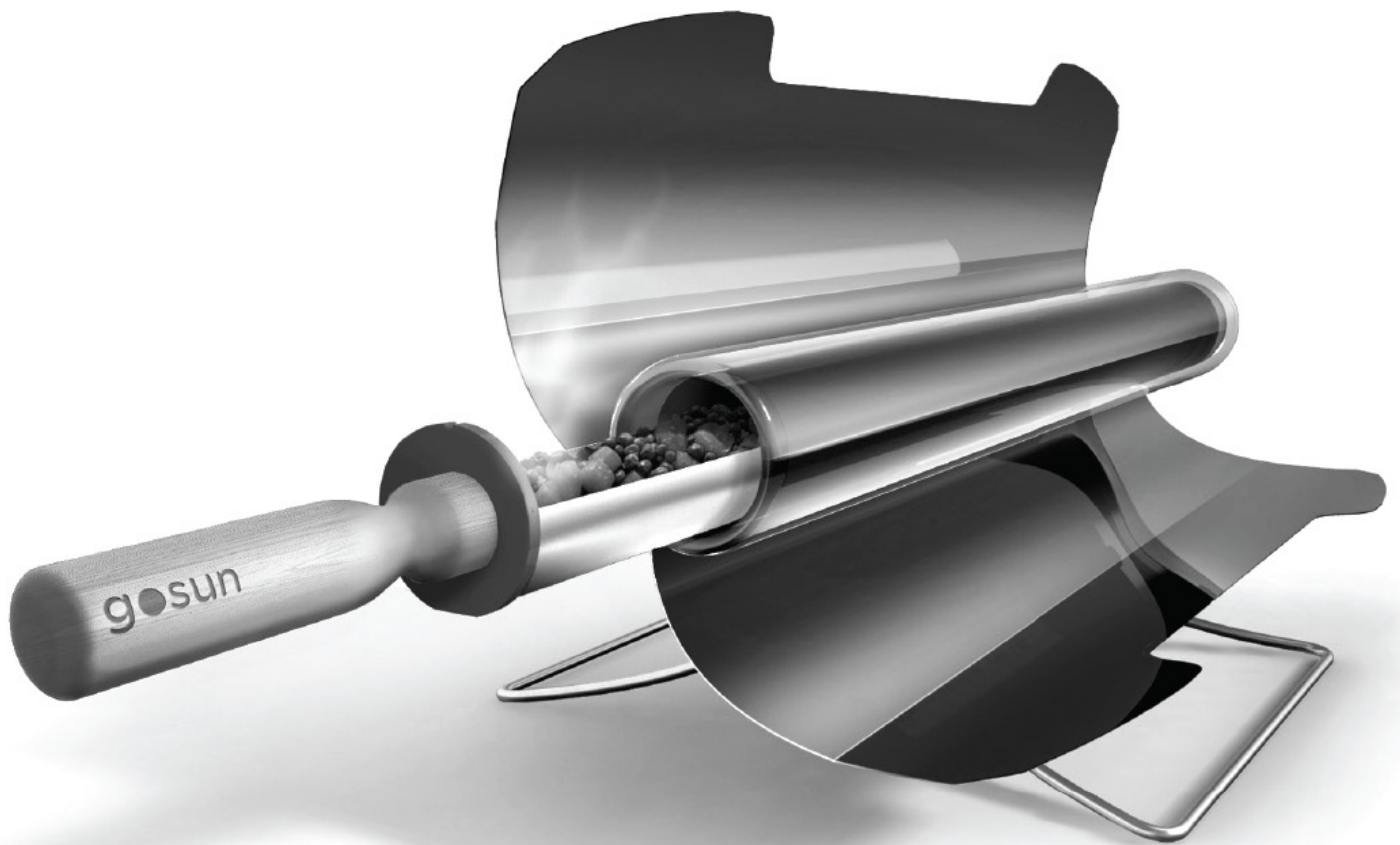

FAST, PRACTICAL, FUEL-FREE
SOLAR COOKER

Part List & Specs

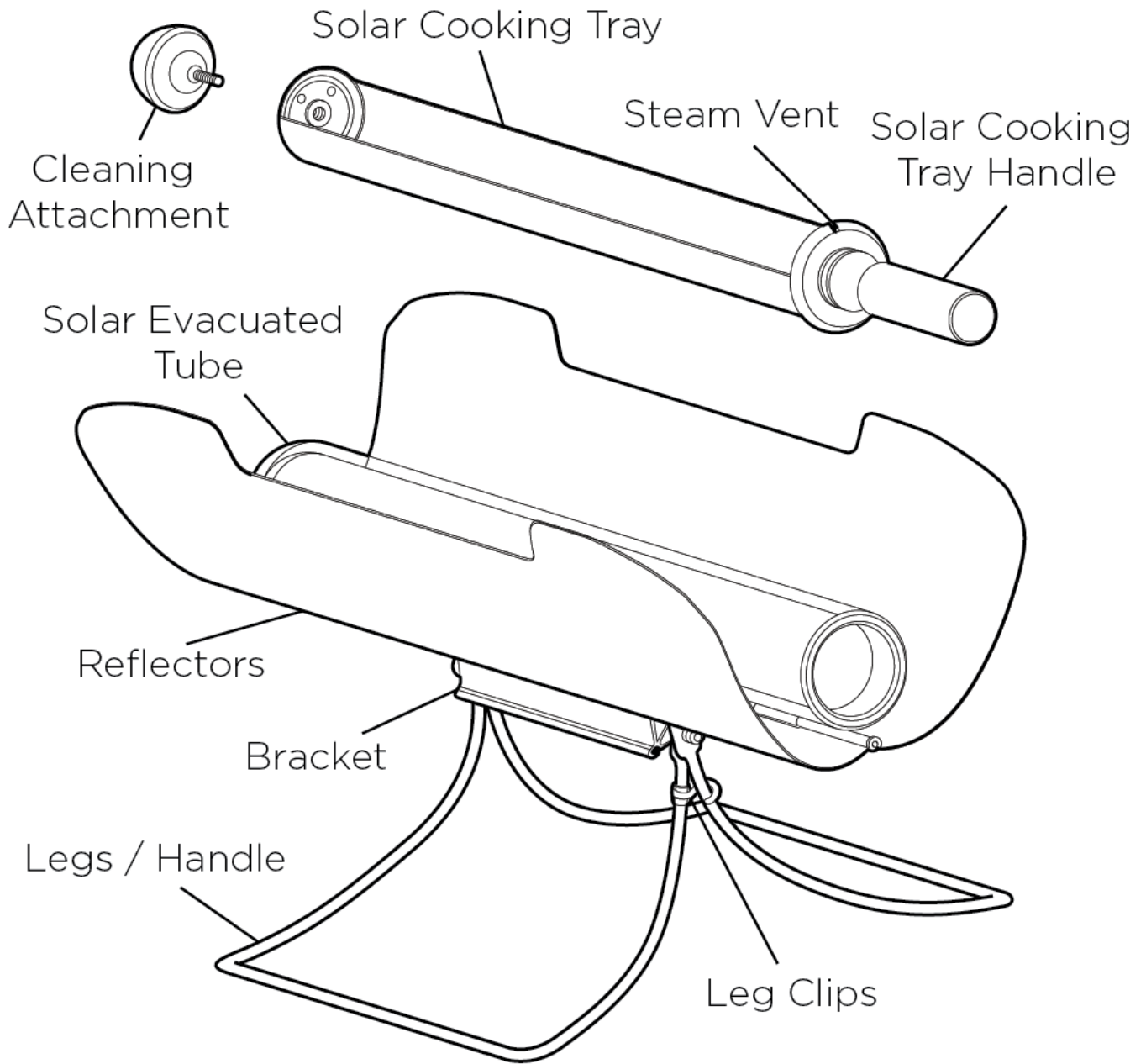

Dry Weight: 7 lbs (3.18 kg) / **Oven Volume:** Up to 3 lbs (1.4kg) of food / **Max Temp:** 700°F (371°C) / **Working Temp:** 200°F (93°C) – 550°F (288°C) / **Cooking Time:** As fast as 10 minutes

1

OPEN STOVE

1. Remove from packaging and peel off protective plastic film on reflectors.
2. Firmly screw the handle onto the cooking tray.
3. Hold the unit in one hand by grasping the central bracket and open legs (rotate about 120°) until they are positioned as shown in picture.
4. Lock legs in place on both sides with leg clips.
5. Open reflectors until they stop.
6. Place GoSun Stove on flat surface or securely fastened when mounting.

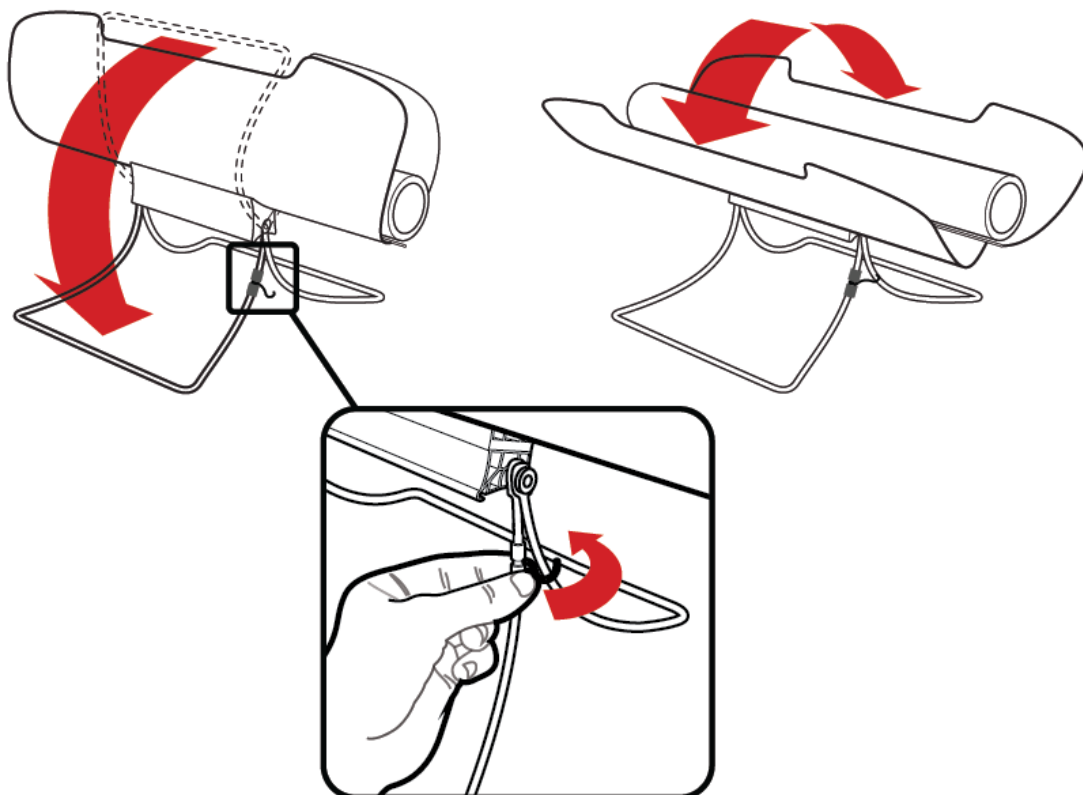

2

ORIENT TO SUN

1. Rotate the GoSun Stove until the reflectors are facing perpendicular to the Sun.
2. Stand in front of the device with your head's shadow aligned on the tube.
3. Tilt device until the reflectors show only the blue of the tube. This indicates that the Sun's rays will all be directed onto the tube.

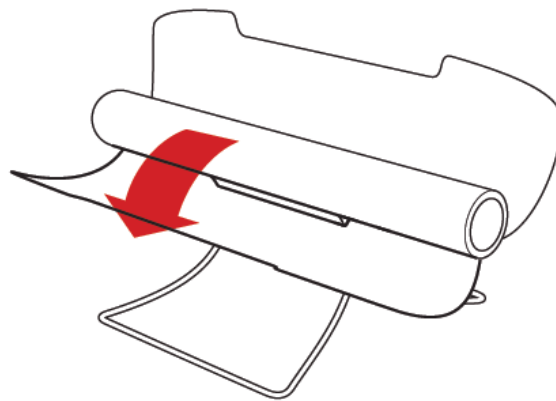

The GoSun Stove only has to be readjusted every hour or so as the Sun moves through the sky.

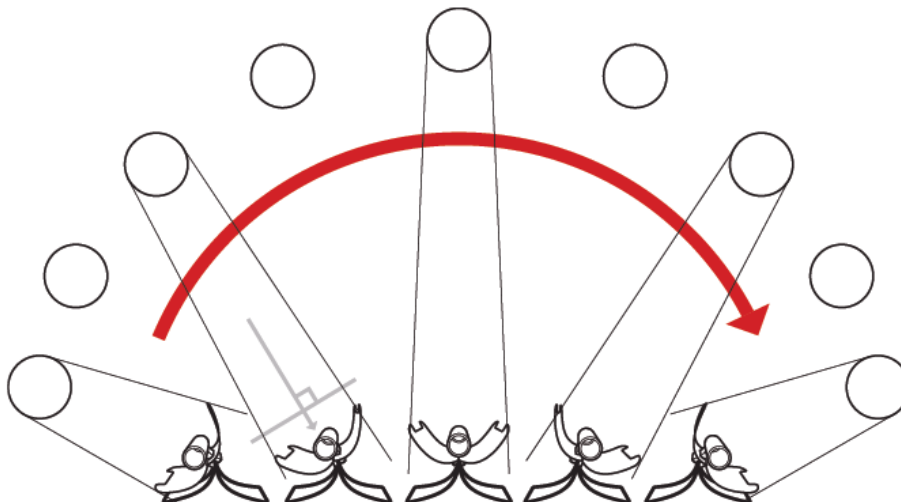

3

INSERT FOOD

1. Fill up the cooking tray with food.
2. Do not allow the cooker to preheat in the Sun more than 10 minutes before placing food inside to avoid thermal shock.
3. Ensure the steam vent is unblocked and faced upwards.
4. Insert cooking tray until handle seal interfaces with the mouth of the tube.

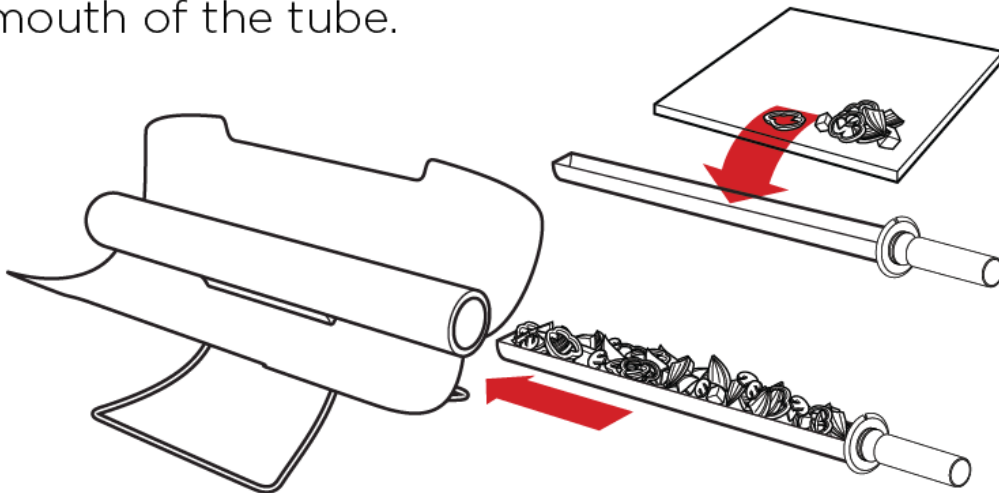

WARNING

- **Do not insert cold food into a hot tube.** It can cause excess stress on the tube, known as THERMAL SHOCK, which may weaken it or cause it to shatter.
- **Do not overload the cooking tray;** many foods expand when heated and can get stuck inside tube.
- **Do not force the cooking tray in tube,** it may break the tube or be difficult to remove.

4

COOK FOOD

1. Let the Sun do its magic (see “Cook Times”).
2. To reduce the temperature or slow cooking times, simply pull the device out the Sun’s direct path or close the reflectors.
3. Enjoy solar cooked food!

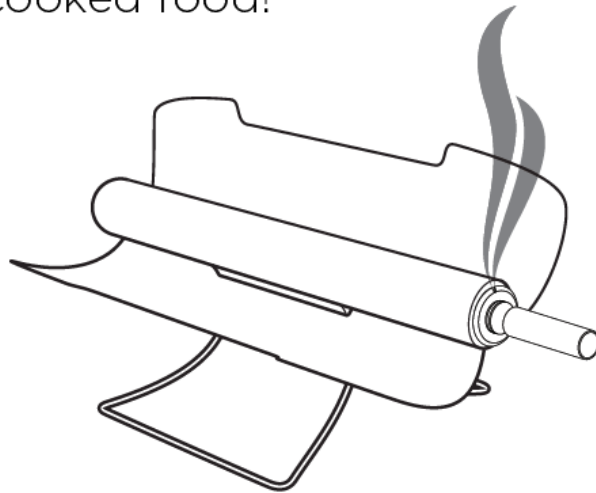

WARNING

- **Hot Contents:** any item placed inside Cooking Tube can be extremely hot and cause severe burns.
- **Use Caution** when handling the device and implements. The GoSun Stove can reach temperatures of up to 700°F, and will begin heating up as soon as it is exposed to Sunlight. Because of the vacuum insulator, you cannot be burned by touching any exterior part of the GoSun Stove. However, inner components can be extremely hot and must be handled with care.

5

COOK TIMES

Sunlight Intensity:

■ Full Sun ■ Good Sun ■ Medium Sun ■ Low Sun

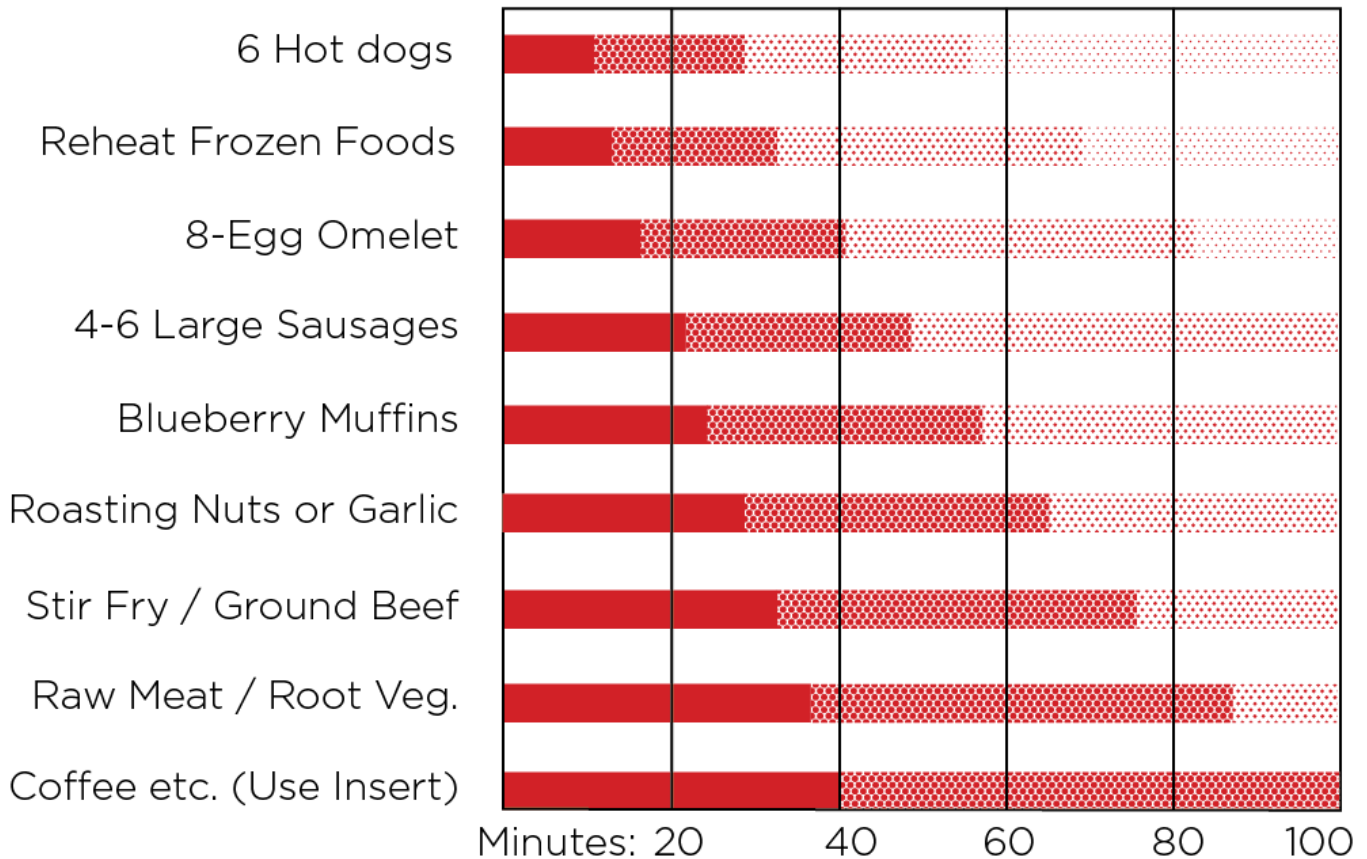

- The GoSun Stove's performance is unaffected by ambient temperatures and wind, cooking meals in frigid temperatures just as well as in hot weather. High humidity, pollution, and diffuse light (generally overcast or "thick" air) can significantly impact cooking times due to light scattering. In humid climates the GoSun Stove will be most efficient in the spring and fall. It will not work in the shade.

6

COOKING TIPS

- Applying aluminum foil, oil and butter to the cooking trays before adding food helps to prevent it from sticking to the steel surface as it cooks.
- Heat is generally distributed evenly to food in the tube but foods at the end of the tray (away from handle) tend to cook better than foods near the tubes opening.
- Baked foods typically expand considerably (more than twice the uncooked volume), so start with small quantities and work up to the full tube size.
- The GoSun Stove tends to trap large amount of moisture from cooking food, and can be used to easily steam vegetables. For a crispier meal, allow the steam to escape by keeping an opening near the hang and drain the fluids periodically.
- Sausages that curl when heated should be cut in half to prevent them from getting stuck.

Other Resources:

- **www.gosunstove.co**
- **<https://www.facebook.com/groups/gosun/>**
Log on and join other GoSun enthusiasts to learn and share recipes and cooking tips.

7

CLEANUP

1. Allow the device to completely cool down out of the Sun – this can take over an hour.
2. Screw the cleaning scrubby tool to the far end of cooking tray (leave handle in place).
3. Fill the tube with about 0.5 liters or 8oz of water and a squirt of dish soap.
4. Insert cooking tray in cool tube and twist in a clockwise direction while plunging up and down.
5. Rinse tray and tube as needed with water (tube must be cool).

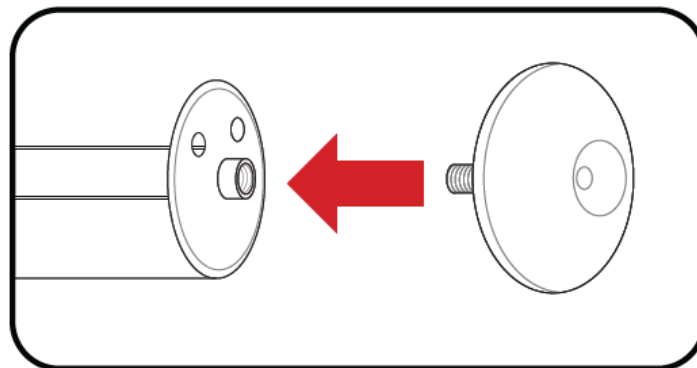

WARNING

- **Do not use harsh abrasives, caustic cleaners or oven cleaners on this device.**

Maintenance

- 1.** The stainless steel cooking tray can easily be cleaned by hand; it can also be cleaned by unscrewing the wooden handle and placing the tray in the dishwasher.
- 2.** It is recommended that you clean the inside of the glass tube after every three uses to prevent build-up of grease or food matter, which can affect the flavor of food.
- 3.** Clean the cooking tray after every use, clean the tube when needed and only after it has cooled down.
- 4.** If the reflectors become deformed due to an impact or other accident, they may be returned to their original shape by bending by hand. A printable reflector is available at (<http://gosunstove.com/pages/reflectorprofile>) and can be cut to check the shape.
- 5.** If the GoSun cooking tray becomes deformed after extensive use and becomes noticeably harder to insert into the tube, it can be remedied by squeezing the tray by hand.
- 6.** If the evacuated tube breaks, it can be removed and replaced by following the “Tube Removal” Section on the opposite side. The GoSun Stove uses the best evacuated tubes available on the market, however if they are damaged, a barium layer will oxidize and a white film will appear on the inside of the outer tube, indicating that the tube should be replaced.



DANGER



AVOID THERMAL SHOCK

- Do Not Preheat Stove.
- Do Not Place Cold Food Inside Hot Tube.
- Do Not Place Liquids Directly Inside Tube.

CONTENTS HOT

- Handle Stove Contents With Extreme Care.

General Safety



- Do not put plastic paper or non-edible items inside the GoSun Stove.
- This device is not intended for use near or by young children or infirm persons without supervision.
- Do not attempt to seal or pressurize the tube.
- Keep tube free of food debris, grit and sand.
- Do not remove warning labels unless specifically for temporary use.
- Do not transport tray inside of tube.
- When removing a broken evacuated tube, the resulting fragments are very sharp. Use caution and only handle shards wearing the appropriate protective gloves to avoid cuts.
- Fragile: Do not drop the tube and be sure to protect it from impacts, scratches and other sources of stress.
- Be sure legs are securely locked in place before loading tube with cooking tray.
- Do not leave device deployed in the sun unattended.
- Keep surfaces of tube and reflectors clean with glass cleaner or mild soap.
- Device not intended for commercial use.
- Clean the cooking tray after every use, clean the tube when needed and only after it has cooled down.
- Use GoSun Stove Implements only with your stove.

How it Works

OUTER SPACE IN A TUBE

At the heart of the GoSun is the evacuated glass tube. It's not only a superior absorber of light, but also a fantastic insulator.

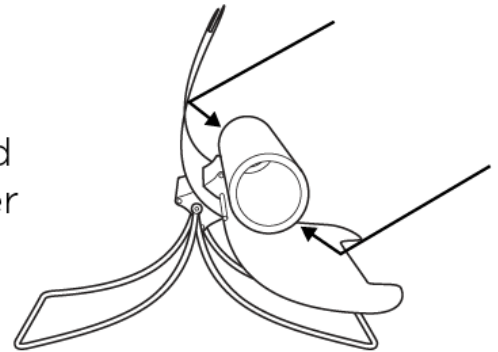

EXTERNAL COATINGS

- ◉ **ALUMINUM NITRILE**
Catching and Absorbing Light
- **STAINLESS STEEL**
Conducting Heat
- ◌ **COPPER**
Trapping Infrared Radiation

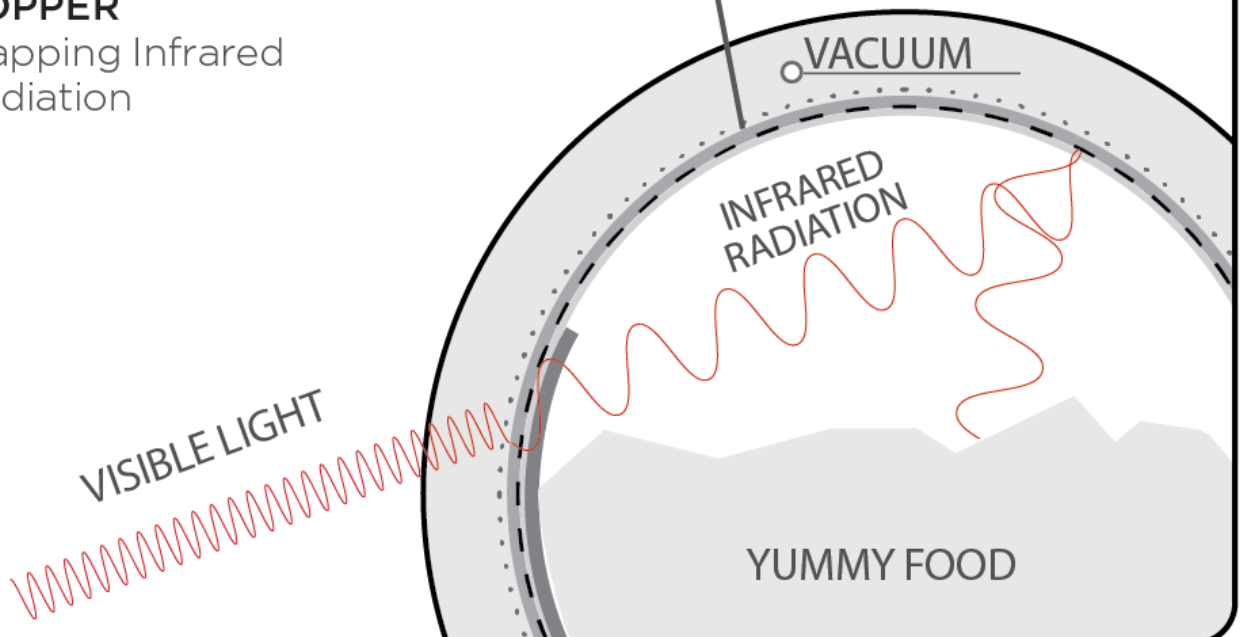

Tube Removal

For cleaning and repairing purposes, the tube can be removed from the rest of the device with the following procedures:

1. Orient stove into Vertical Position (see “Turn Vertical”).
2. Locate tube release set screws on the under side of the top bracket.
3. Using a screwdriver, loosen set screws no more than three rotations counterclockwise.
4. Firmly grasping tube in one hand and bracket in the other, slide tube out of the bracket by pushing the tube toward the closed end. Be careful not to force the tube or knock it on hard surfaces.
5. Repeat these steps in reverse order to put tube back in place. Don't forget to tighten the set screws.

To Mount Onto a Tripod:

1. Only use a tripod capable of handling the weight and torque of the GoSun Stove loaded with food.
2. Locate the tripod mount on the underside of the top bracket by rotating bracket to the vertical mode (see “Turn Vertical”).
3. Connect tripod into the 1/4 20 female threaded slot.
4. Be sure to tighten securely.
5. Use the tripod's head to adjust the tilt angle.

Turn Vertical

1. Start with locked legs and open reflectors (See “Open Stove” directions on opposite side of manual).
2. Grip the center of the tube firmly in one hand, and the bottom bracket in the other.
3. Pull them away from each other until the top and bottom bracket separate enough to rotate.
4. Twist the tube 90°, then gently release the tube as it locks in its new place on the bottom bracket.
5. Orient the stove in the vertical position by pointing reflector tips toward the sun.

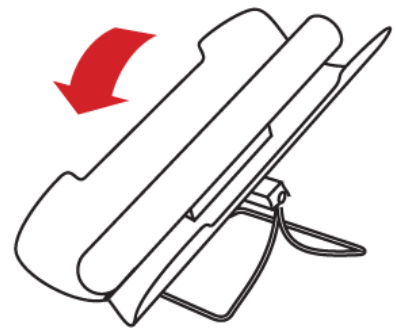
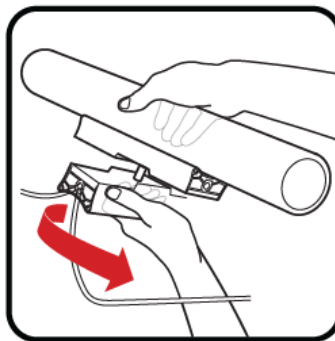
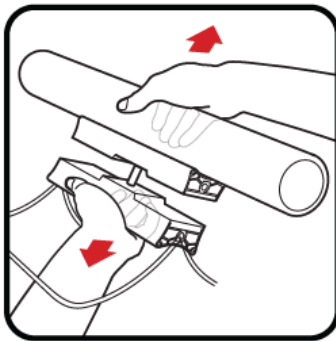

WARNING

- **Do not boil water or cook food directly in the tube:** always use either the GoSun cooking trough, the Boiling Insert, or another product specifically designed for use in the GoSun Stove.

Liability Release

By using the GoSun Stove, the Purchaser and User acknowledges that cooking is an activity that puts you at some amount of risk. The Purchaser and User also acknowledge that it is critical to have read and understood the entire contents of the User's Manual. Applied Sunshine, LLC, (DBA, "GoSun Stove") is not liable for damage or injury caused by misuse, abuse, or results from failure to implement the proper safety precautions.

The Purchaser and User will thus release of the rights to sue for injuries or death resulting from the purchased, donated, loaned, rented, modified, or repaired equipment received from GoSun Stove.

Purchaser and Users also understands that Applied Sunshine, LLC, (DBA, "GoSun Stove"), and its employees, owners, officers, or agents (hereinafter "Released Parties"), shall not be held liable or responsible in any way for injury, death, or other damages to the User or his/her family, heirs, or assigns which may occur as a result of the sold, donated, loaned, repaired, or modified equipment, or as a result of product defect, wear and tear, or the negligence of any party, including the Released Parties, whether passive or active.

Warranty



To activate your warranty, register at
www.gosunstove.com/register

The GoSun Stove evacuated tube is made of glass — It uses the same tough borosilicate glass as Pyrex, but it can break. All purchases are backed with a Two-Year Limited Tube Warranty on the evacuated tube.

We're ensuring your satisfaction with a No-Questions-Asked-Policy; if you break the tube for any reason, we will cover the one-time cost of a new tube. You will have to cover a nominal shipping and handling fee. You will be required to provide some information, but you will not have to return the damaged tube.

To claim your warranty, read the Warranty Policy below and send an email to warranty@gosunstove.com and follow instructions provided. Please direct your warranty inquiries either to your local retailer or to internationalwarranty@gosunstove.com. The rest of the package is guaranteed from manufacturing defects by a One-Year Limited Warranty. This does not cover damage caused by normal wear and tear, accident, improper care or cleaning, non-standard usage or negligence. Any replacements or exchanges will be at the discretion of GoSun Stove, based on the type of product sent in and the availability of replacement parts. Typically, most issues can be resolved with a little guidance or a replacement part.

WARRANTY POLICY

Applied Sunshine, LLC, (DBA "GoSun Stove") extends this Limited Warranty to the original end-use purchaser of GoSun Stove products* (including GoSun Mini, GoSun Mighty, each a "Product") or the person receiving a Product as a gift, provided that the GoSun Stove Product was purchased from an Authorized Dealer as defined below. The Limited Warranty does not extend to any other person or transferee. Statutory or common law may provide additional rights or remedies that vary from state to state, and country to country, which are not affected by this Limited Warranty.

DEFINITIONS

"Authorized Dealer" means any distributor, reseller or retailer that was duly authorized by GoSun Stove at the time of the sale to sell authentic GoSun Stove products in the jurisdiction where it sold the Product, and that sold the Product in

new, unused condition in its original packaging.

“Fraud or Misrepresentation” means misrepresenting any fact related to a warranty claim to GoSun Stove, including the nature of the defect, whether the Product was purchased from an Authorized Dealer, and the authenticity of the Product.

“Intended Use” means use of the Product (a) for food preparation, (b) for private (as opposed to commercial) purposes, (c) in conformity with all applicable local, state or federal law, code or regulations, (d) in accordance with GoSun Stove recommendations and/or instructions in the materials and documentation that accompany the Product.

SCOPE OF TWO-YEAR LIMITED TUBE WARRANTY

Evacuated tube failures claimed, submitted, reviewed and approved by GoSun Stove, within two years of original purchase, will convert into a One-Time Tube Credit to the purchaser. The One-Time Tube Credit is then applied to a replacement tube to be sent directly to the purchaser’s address of choice. This Credit for may not be used toward any other GoSun Stove products such as GoSun Stove Apparel and accessories. Note that GoSun Stove regularly changes the models, and styles of its Products and cannot guarantee the availability of an exact replacement for any Product. The Purchaser will be responsible for the cost of shipping and handling fees to receive their replacement tube. The exact cost for shipping and handling will be covered during the warranty claim process.

SCOPE OF ONE-YEAR LIMITED WARRANTY

GoSun Stove provides a One-Year Limited Warranty against Manufacturing Defects for all authentic GoSun Stove Products. If a Product contained a Manufacturing Defect when it was purchased from an Authorized Dealer, GoSun Stove, at its sole discretion, will (i) repair, (ii) replace, or (iii) provide a Warranty Credit for the Product on the GoSun Stove online store. The amount of the Warranty Credit shall be equal to the purchase price of the Product paid to the Authorized Dealer. GoSun Stove reserves the right to inspect any Product subject to a warranty claim to determine, at its sole discretion, whether the claimed defect is a Manufacturing Defect or otherwise.

GOSUN STOVE DOES NOT ASSUME ANY LIABILITY FOR ANY INCIDENTAL, CONSEQUENTIAL OR INDIRECT DAMAGES UNDER THIS LIMITED WARRANTY.

How it Works

OUTER SPACE IN A TUBE

At the heart of the GoSun is the evacuated glass tube. It's not only a superior absorber of light, but also a fantastic insulator.

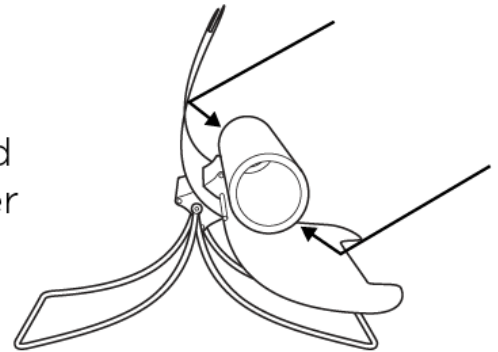

EXTERNAL COATINGS

⋯ **ALUMINUM NITRILE**
Catching and Absorbing Light

○ **STAINLESS STEEL**
Conducting Heat

⌋ **COPPER**
Trapping Infrared Radiation

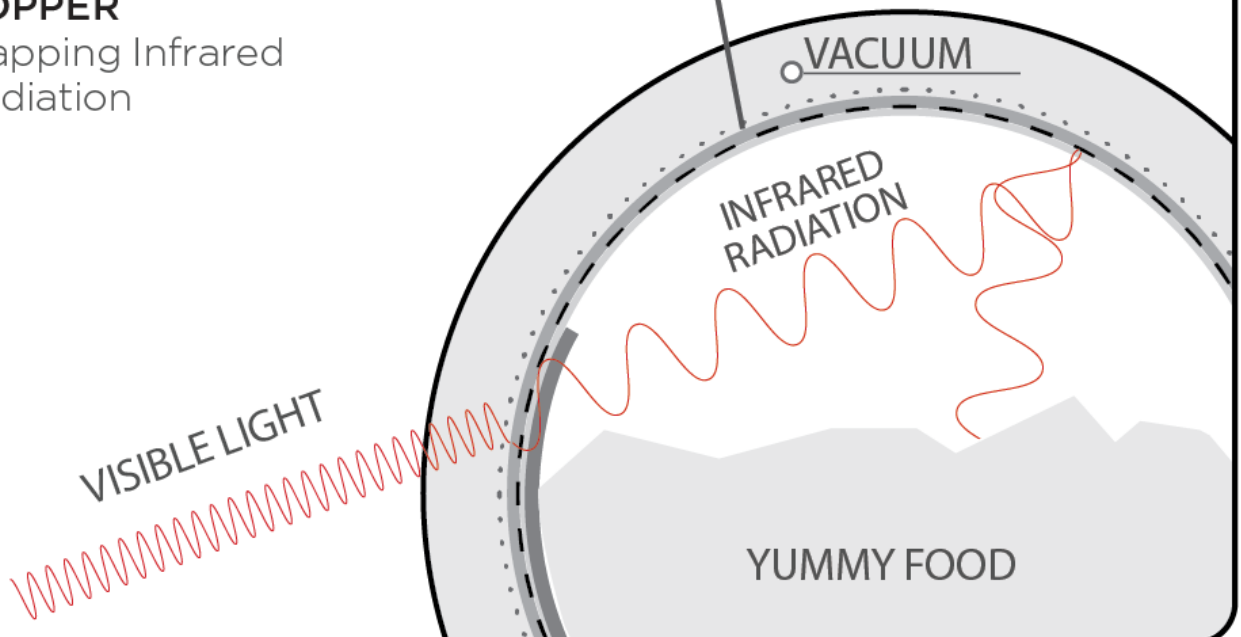

TERMS AND CONDITIONS

By submitting this warranty request, you agree to the following Terms and Conditions:

- In the case of Fraud or Misrepresentation, GoSun Stove reserves the right to deny all warranty coverage or claims.
- Risk of Loss- GoSun Stove is not responsible for any Product that is lost in shipping and not actually received by GoSun Stove. To avoid unnecessary delays and minimize the possibility of a lost Product, we strongly suggest that you use the return label provided to you by GoSun Stove's online warranty system to send your Product to GoSun Stove. No warranty will be provided for any Product not actually received by GoSun Stove.
- GoSun Stove reserves the right to determine, at its sole discretion, whether a defect is a manufacturing defect and what type of credit or replacement shall be issued, if any.
- All warranty Products sent to GoSun Stove will not be returned to you for any reason. Defective Products may be subject to engineering analysis and recycling, as part of our continued commitment to improving the quality of our products and the environment.

CHOICE OF LAW/JURISDICTION

This Limited Warranty and any disputes arising out of or in connection with this Limited Warranty ("Disputes") shall be governed by the laws of the State of Ohio, USA, excluding conflicts of law principles and excluding the Convention for the International Sale of Goods. The courts located in the State of Ohio, USA shall have exclusive jurisdiction over any Disputes.

OTHER RIGHTS

THIS LIMITED WARRANTY GIVES YOU SPECIFIC LEGAL RIGHTS, AND YOU MAY ALSO HAVE OTHER RIGHTS, WHICH VARY FROM STATE TO STATE AND JURISDICTION TO JURISDICTION, AND WHICH SHALL NOT BE AFFECTED BY THIS LIMITED WARRANTY. THIS WARRANTY EXTENDS ONLY TO YOU AND CANNOT BE TRANSFERRED OR ASSIGNED. If any provision of this Limited Warranty is unlawful, void or unenforceable, that provision shall be deemed severable and shall not affect any remaining provisions. In case of any inconsistency between the English and other versions of this Limited Warranty, the English version shall prevail.

REFUNDS AND EXCHANGES

All refunds and exchanges are handled through your retailer or distributor.

Contact Us

Please 'Like' us on Facebook and post your recipes or visit our website www.GoSunStove.com to learn more.

Activate your warranty now at www.gosunstove.com/register

GoSun Stove is a DBA of Applied Sunshine, LLC.

Direct any questions or issues to:
support@gosunstove.com

GoSun Stove and GoSun Grill are trademarks of GoSun Stove registered in the U.S. and other countries. Copyright © 2016 GoSun Stove. All rights reserved.

