

## Montagehand- leiding:

Hartelijk gefeliciteerd met de aankoop van dit kwaliteitsproduct van JOKA.

57 Lees deze handleiding voor de eerste ingebruikname volledig door en bewaar ze samen met de buitenverpakking voor als u later nog vragen hebt.

### ATTENTIE:

Voor de montage van 2 volwassenen nodig zijn.











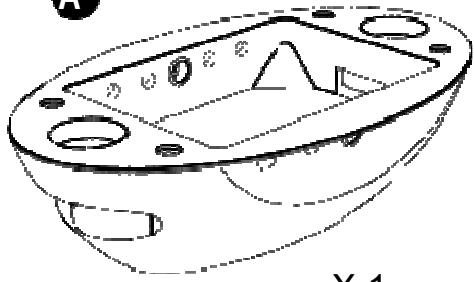
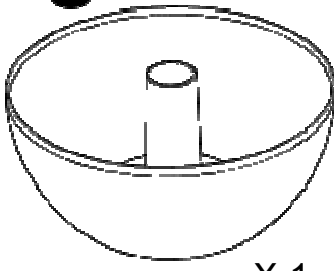
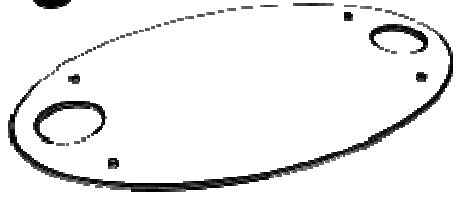
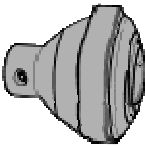
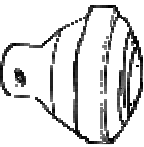







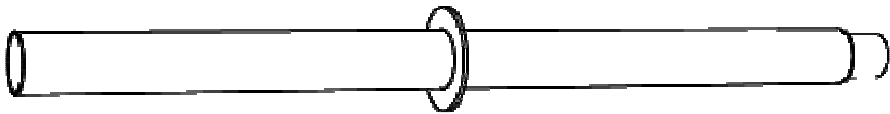
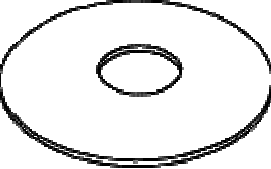

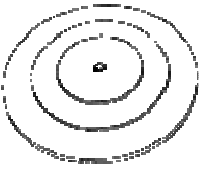

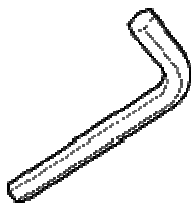
Voorafgaand aan de installatie te beginnen, dat er voldoende ruimte beschikbaar is en alle onderdelen van de stuklijst zijn opgenomen.

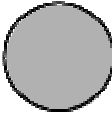
Om te voorkomen dat er krassen op een zachte ondergrond (bv tapijt) monteren.

### VEILIGHEID:

Voor het eerste gebruik, dat alle schroeven worden aangedraaid. Gebruik door kinderen onder toezicht van een volwassene toegestaan. Gebruik geen zichtbare schade. Verwijderd houden van open vuur of andere warmtebronnen.

Toebehorenlijst:

- A**  X 1
- B**  X 1
- C**  X 1
- D1**  X 2
- D2**  X 2
- E1**  X 6
- E2**  X 6
- F**  X 8
- G**  X 8
- H**  X 4
- I**  X 1
- J**  X 4
- K**  X 1
- L** X 1 
- M** X 1 
- N** X 1 
- O** X 2 
- P** X 1 
- Q** X 1 
- R1** X 1 **R2** X 1 
- 
- S** X 4 
- T**  X 1
- U**  X 1
- V**  X 4
- W**  X 12
- X**  X 4
- Y**  X 4

# Montage op staan featuring:

Stap 1:

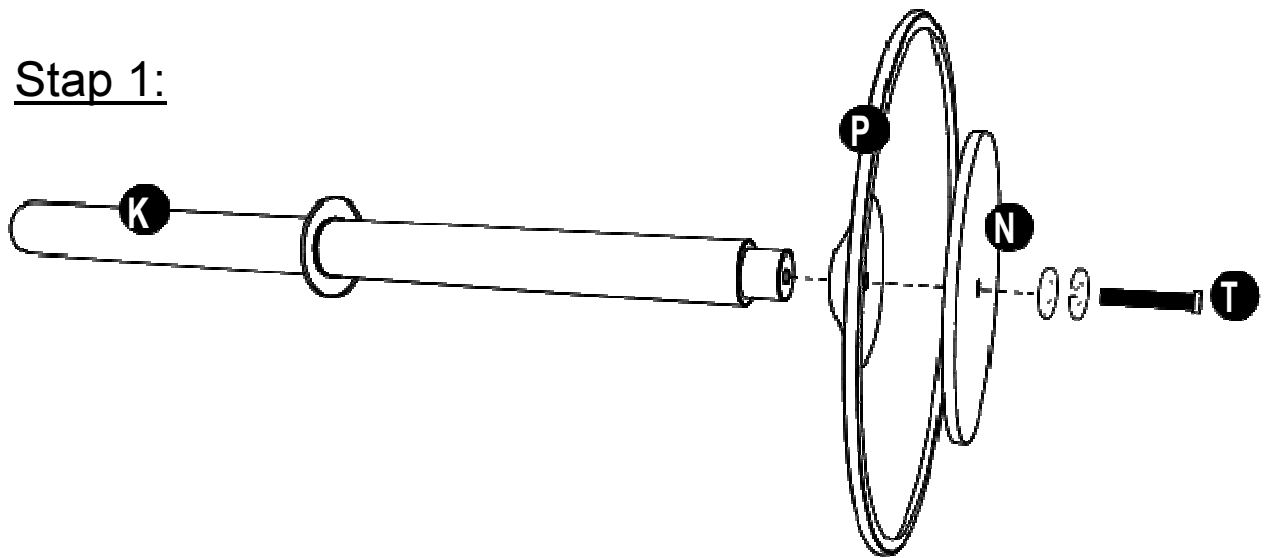

Stap 2:

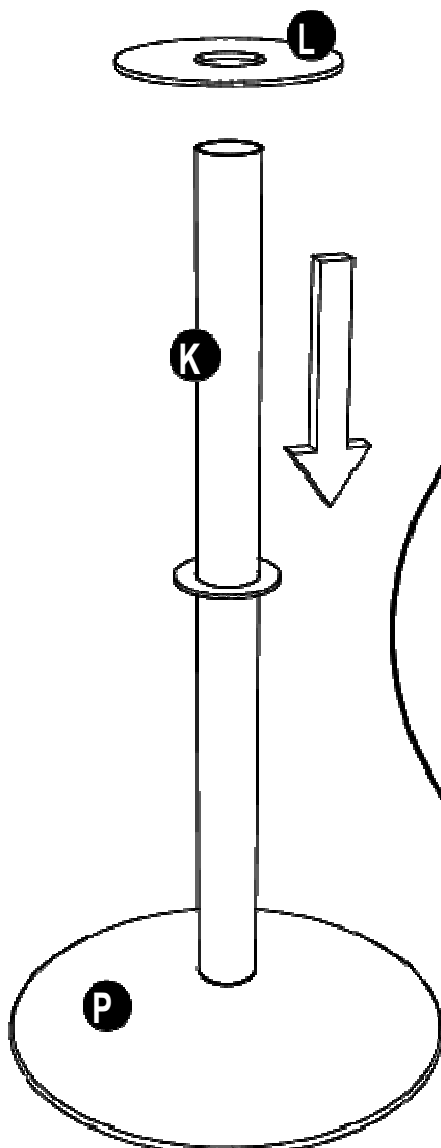

Stap 3:

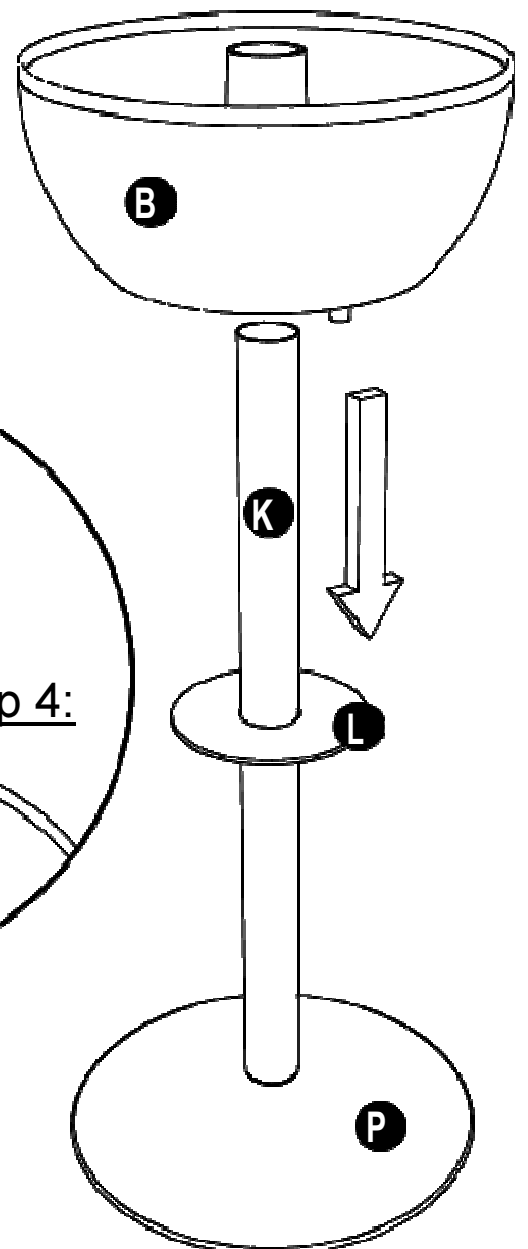

Stap 4:

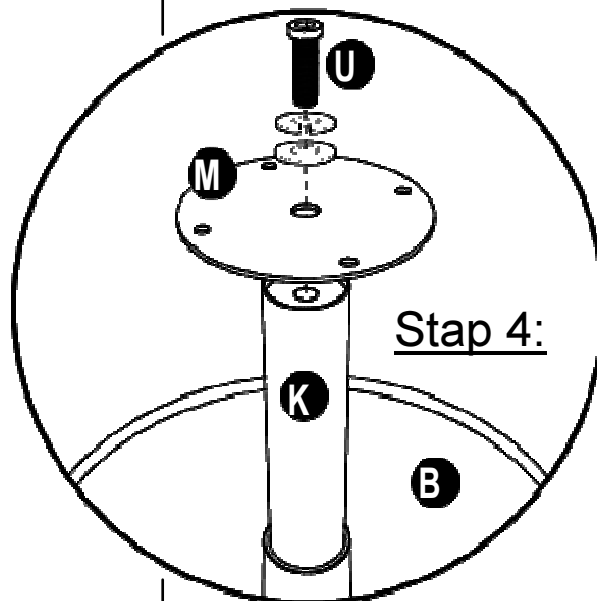

# Montage op tafel:

## Stap 5:

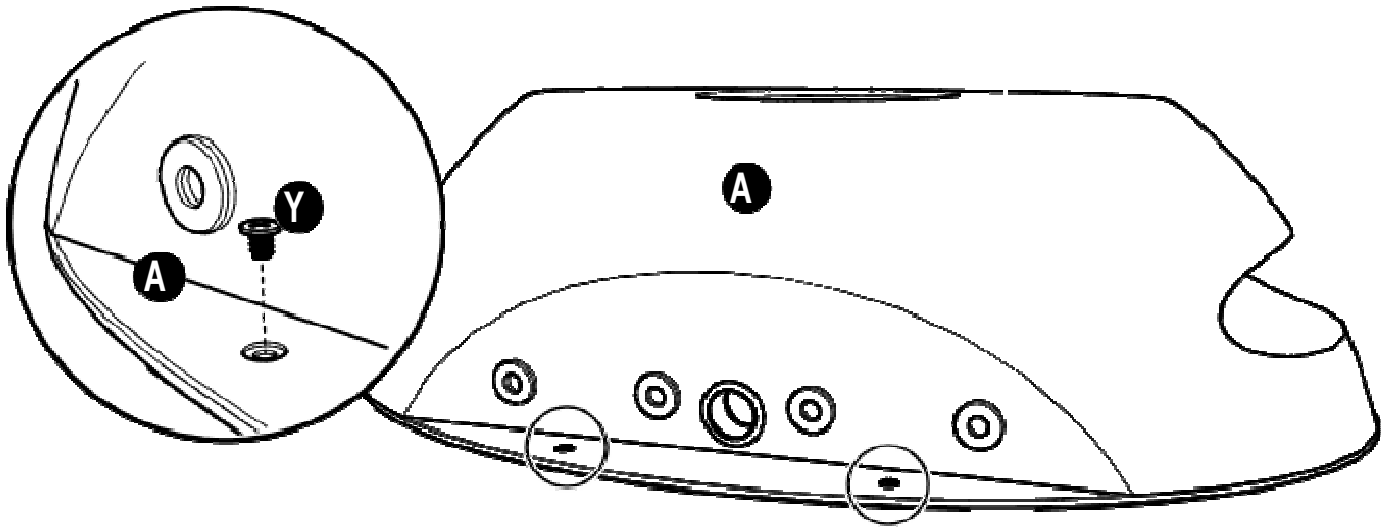

## Stap 6:

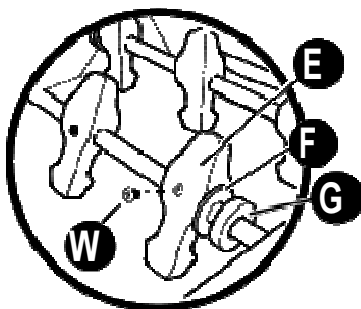
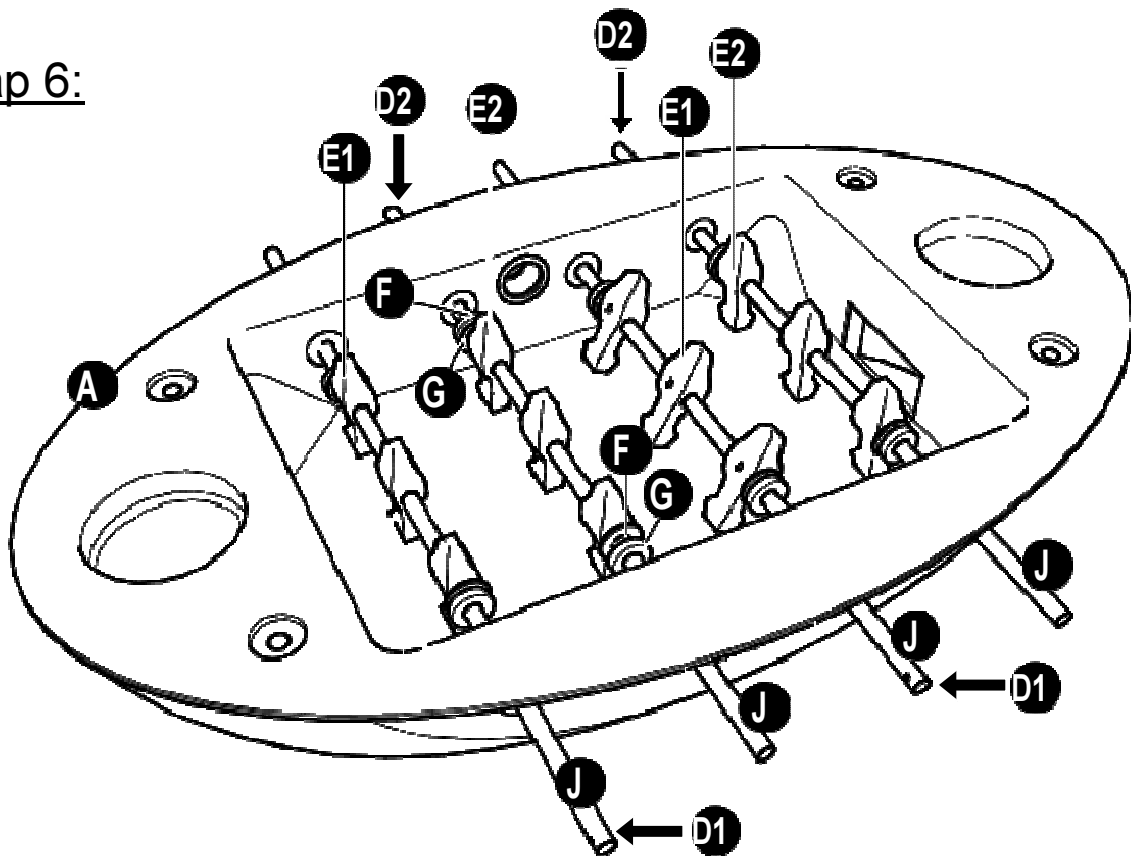

Stap 7:

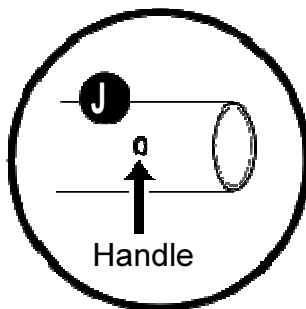

Stap 8:

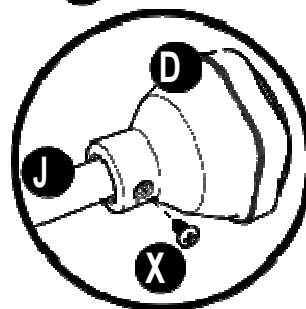

Stap 9:

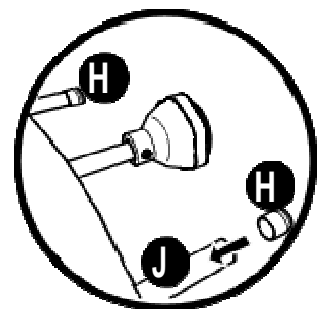

Stap 10:

## Montage op tafel:

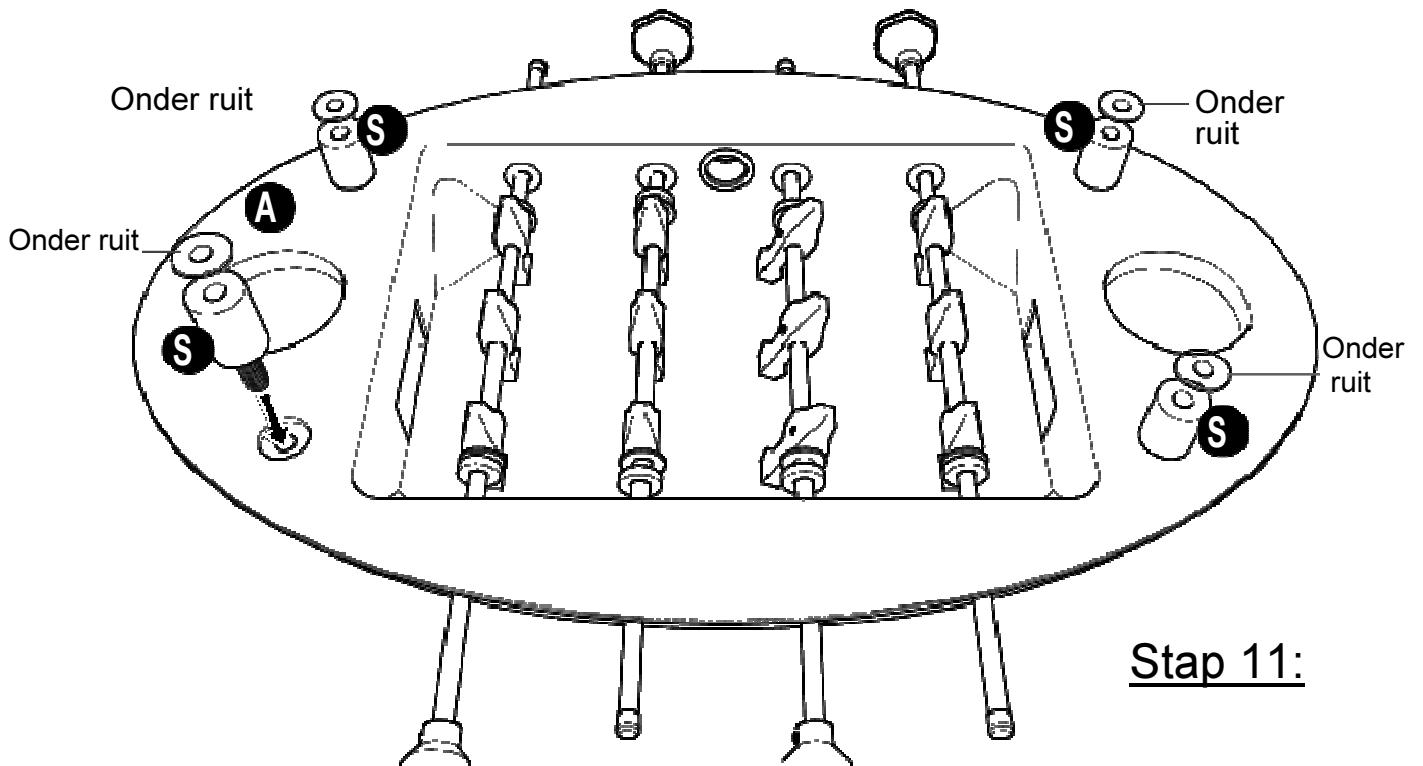

## Montage op tafel:

Stap 13:

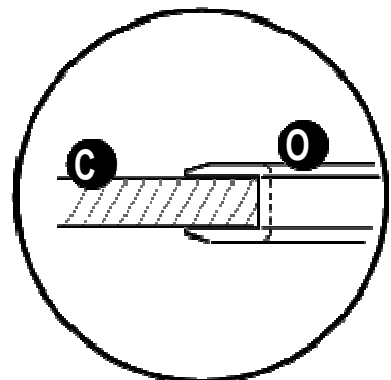
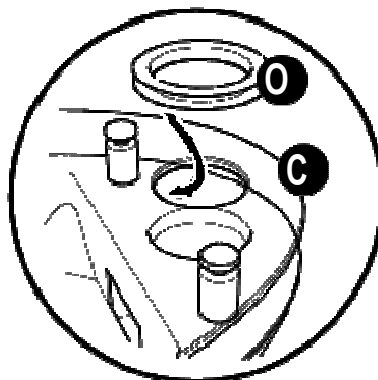

Stap 12:



# Montage op tafel met staan featuring:

Stap 14:

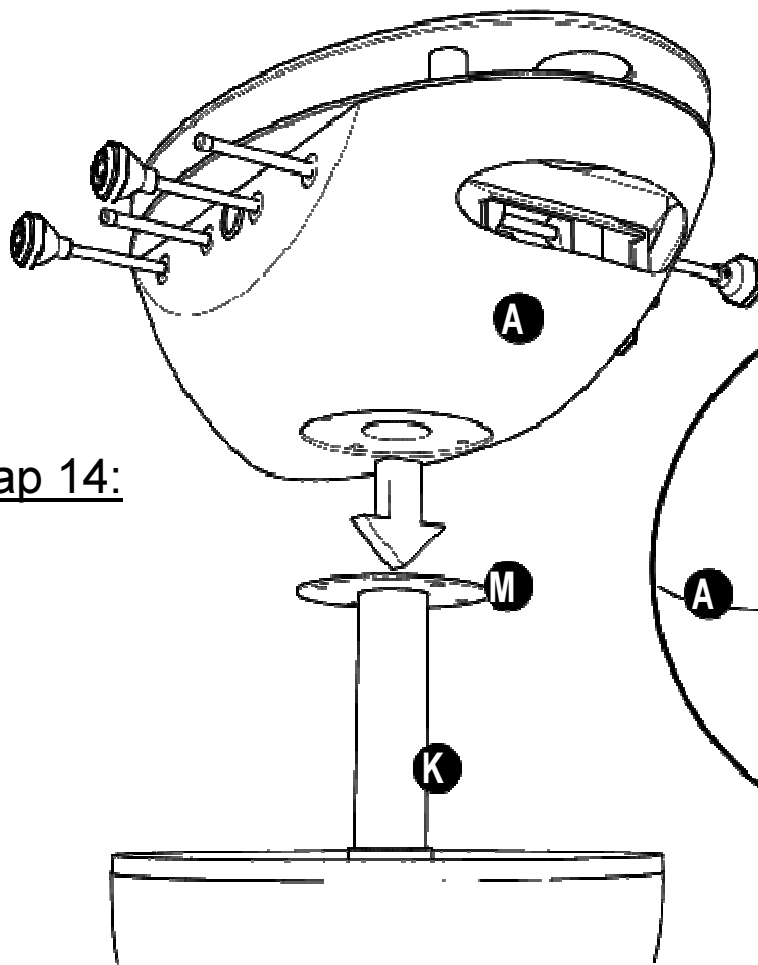

Stap 15:

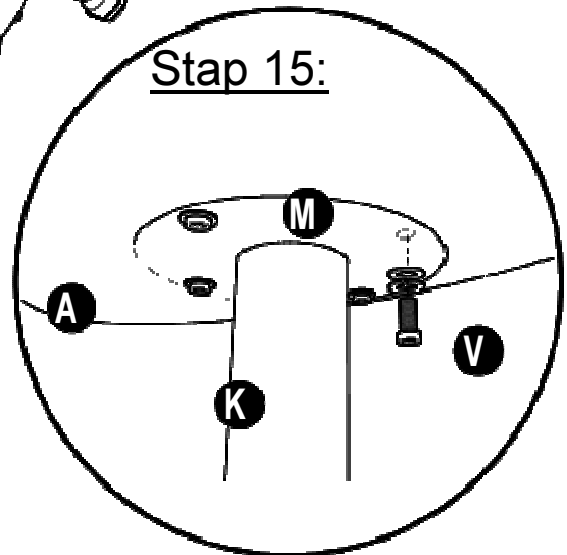

Stap 16:

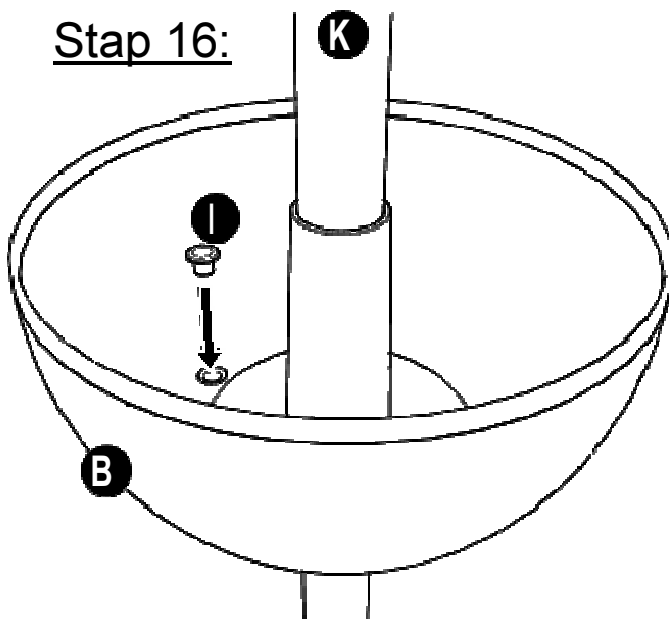

Stekker voor het vullen met ijs, de dop (I) in de kom (B).

