

# Assembly Instructions

## **WARNINGS**

This product must be assembled and dismantled at least two adults. Ensure you have enough space before assembly, check that you have all the parts before assembly. To avoid scratching it is recommended that you assemble the product on a flat surface.

## **SAFETY NOTES**

Check all bolts and screws are tightened time to time before use. This product for adults use, Do not allow children shake or climb onto this product. Discontinue use if any breakage is found, failure to do this may result in injury. Keep away from fire and heat sources.

This product is heavy a minimum of two persons should be used to manoeuvre this product.

# Parts List

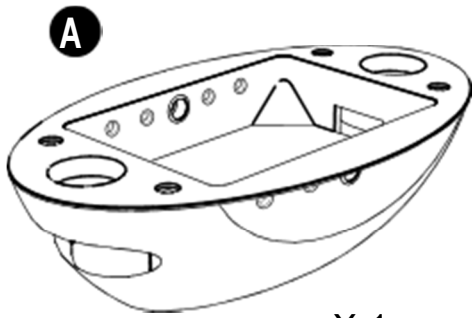

X 1

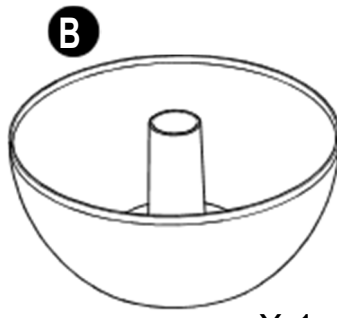

X 1

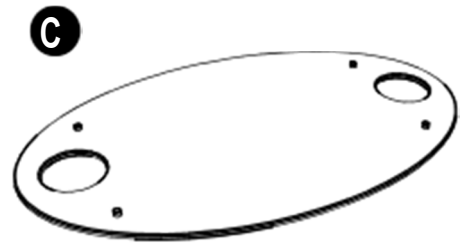

X 1

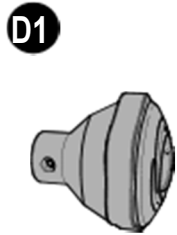

X 2



X 2



X 6



X 6



X 8



X 8



X 4



X 1

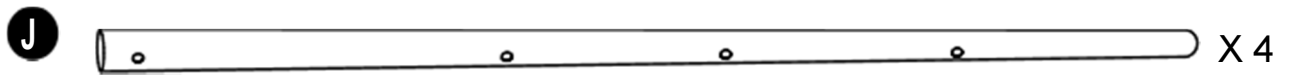

X 4

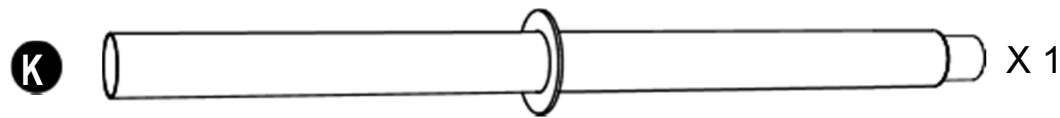

X 1

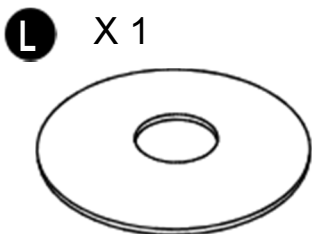

X 1

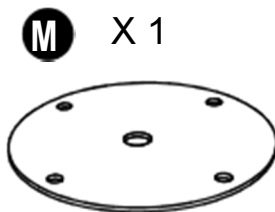

X 1

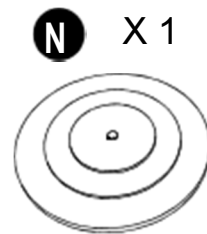

X 1

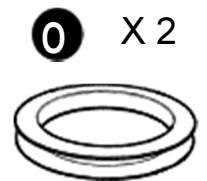

X 2

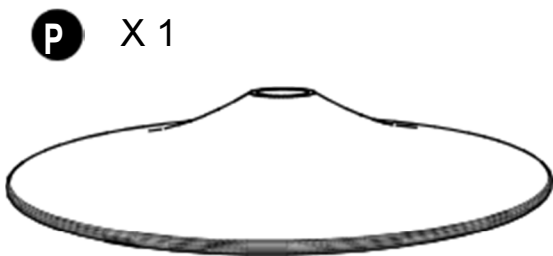

X 1

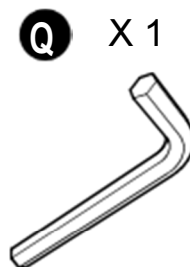

X 1



X 1

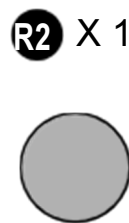

X 1

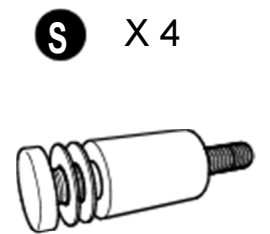

X 4

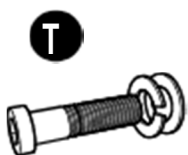

X 1



X 1



X 4



X 12



X 4



X 4

# Assembling for the base unit

Step.1

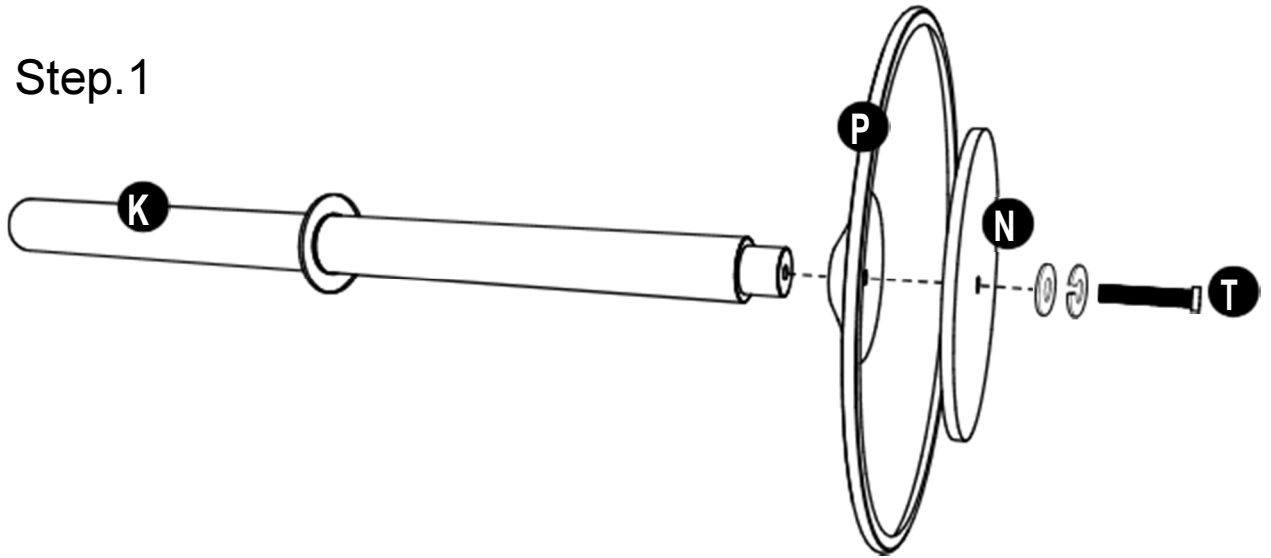

Step.2

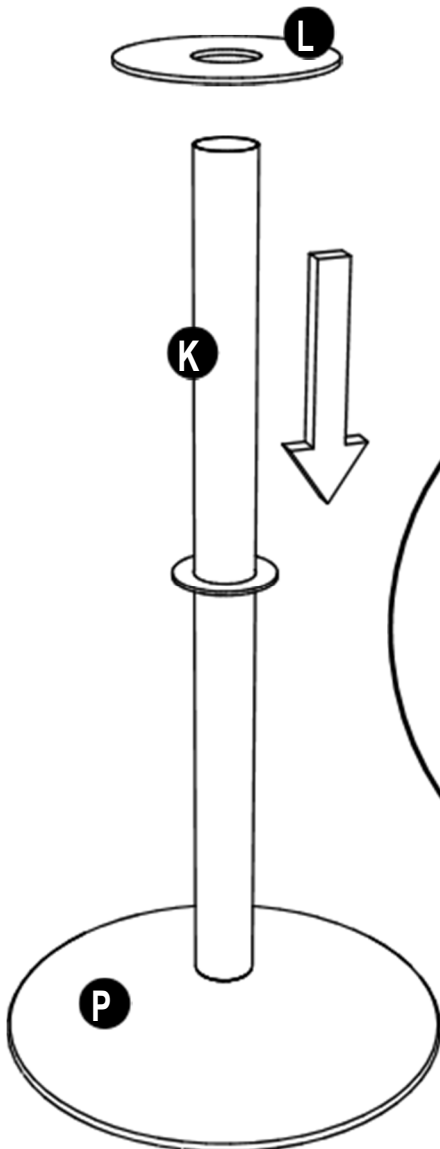

Step.3

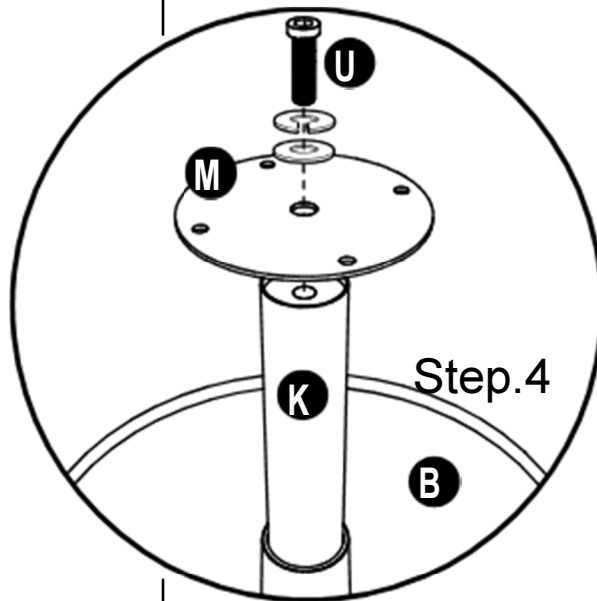
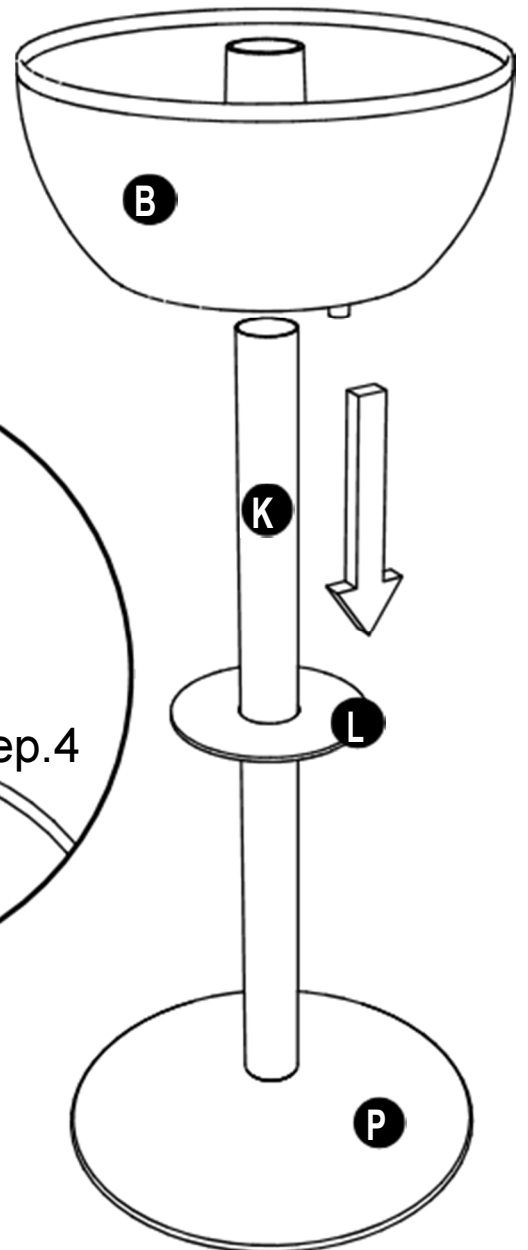

# Assembling for the table top unit

## Step.5

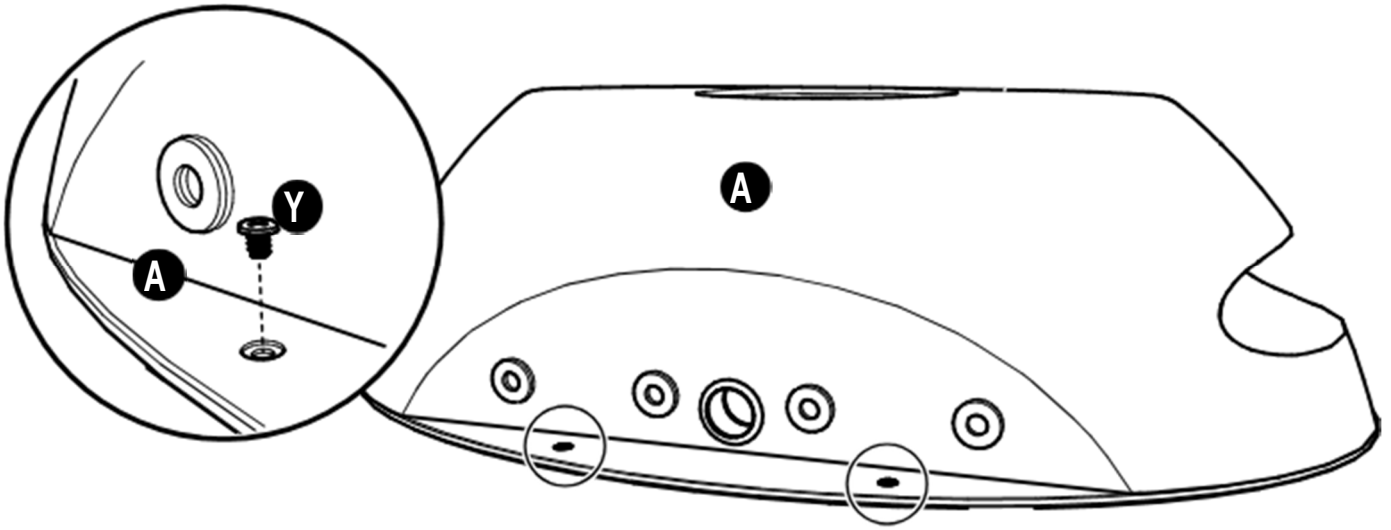

## Step.6

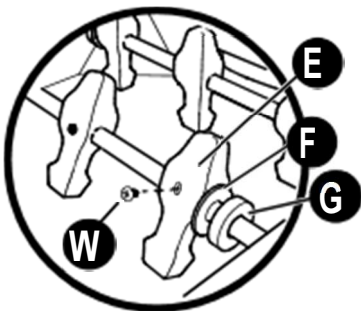
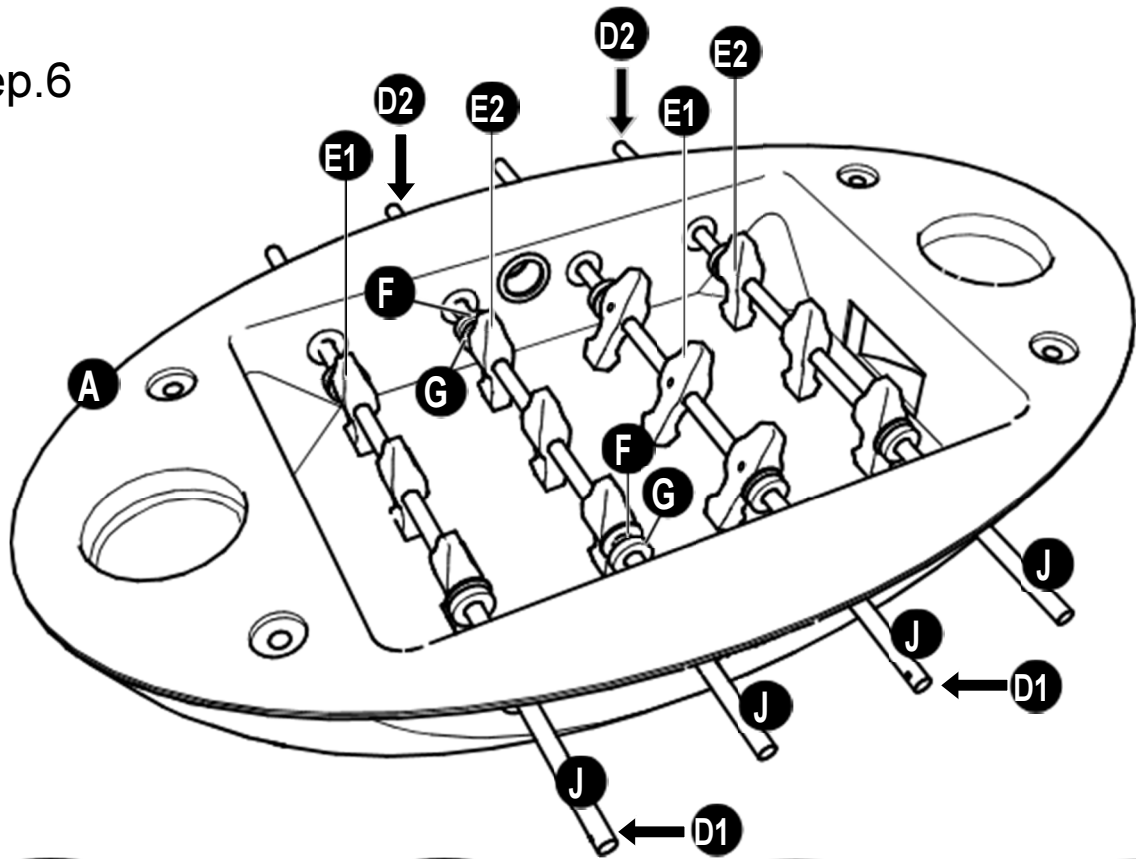

Step.7

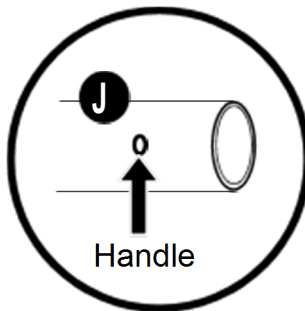

Step.8

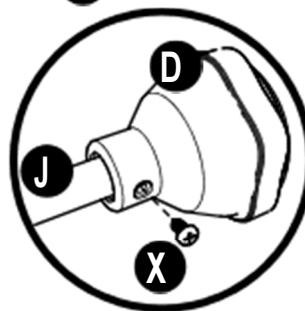

Step.9

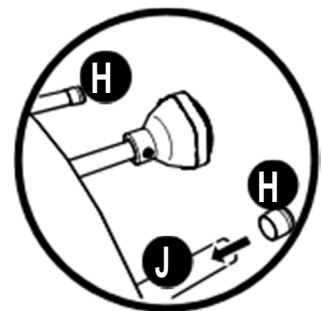

Step.10

## Assembling for the table top unit

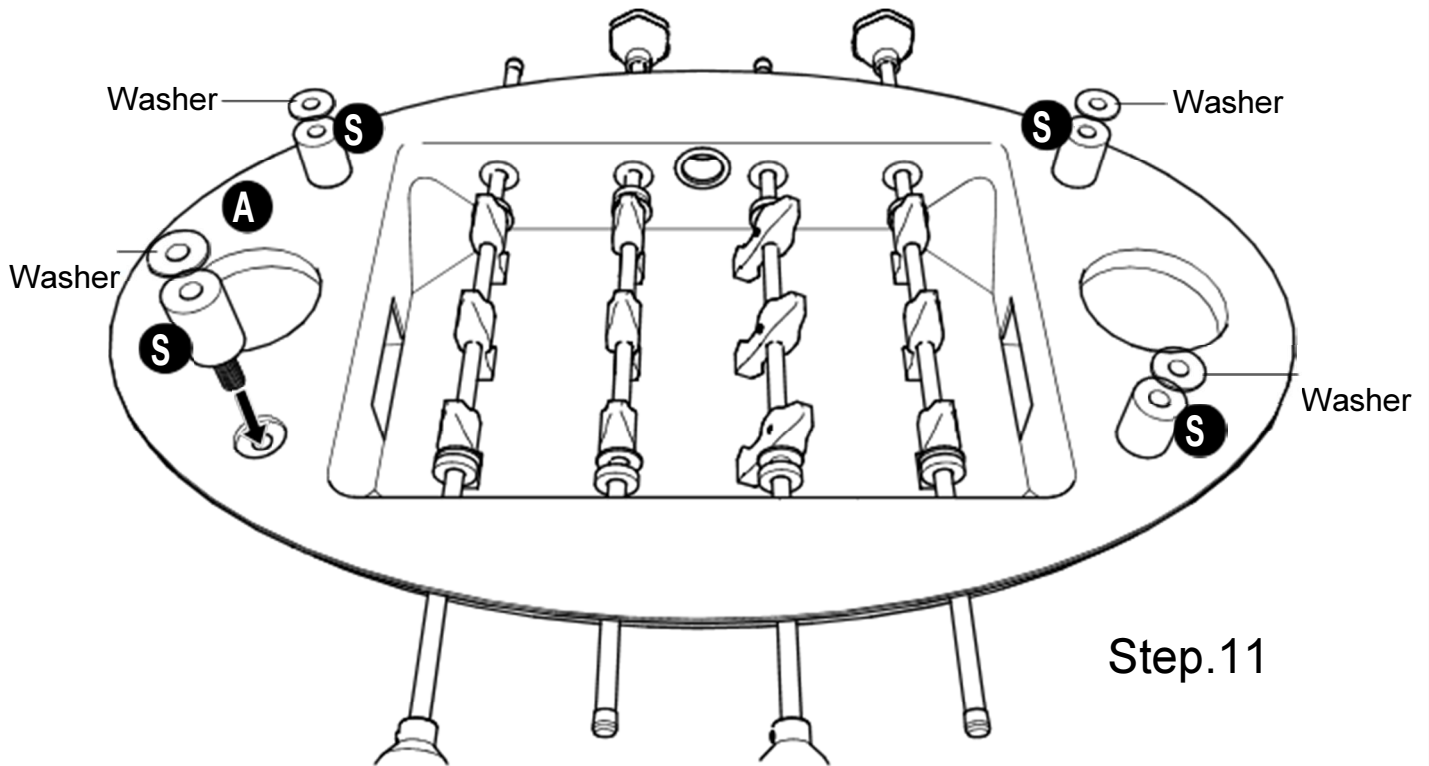

## Assembling for the table top unit

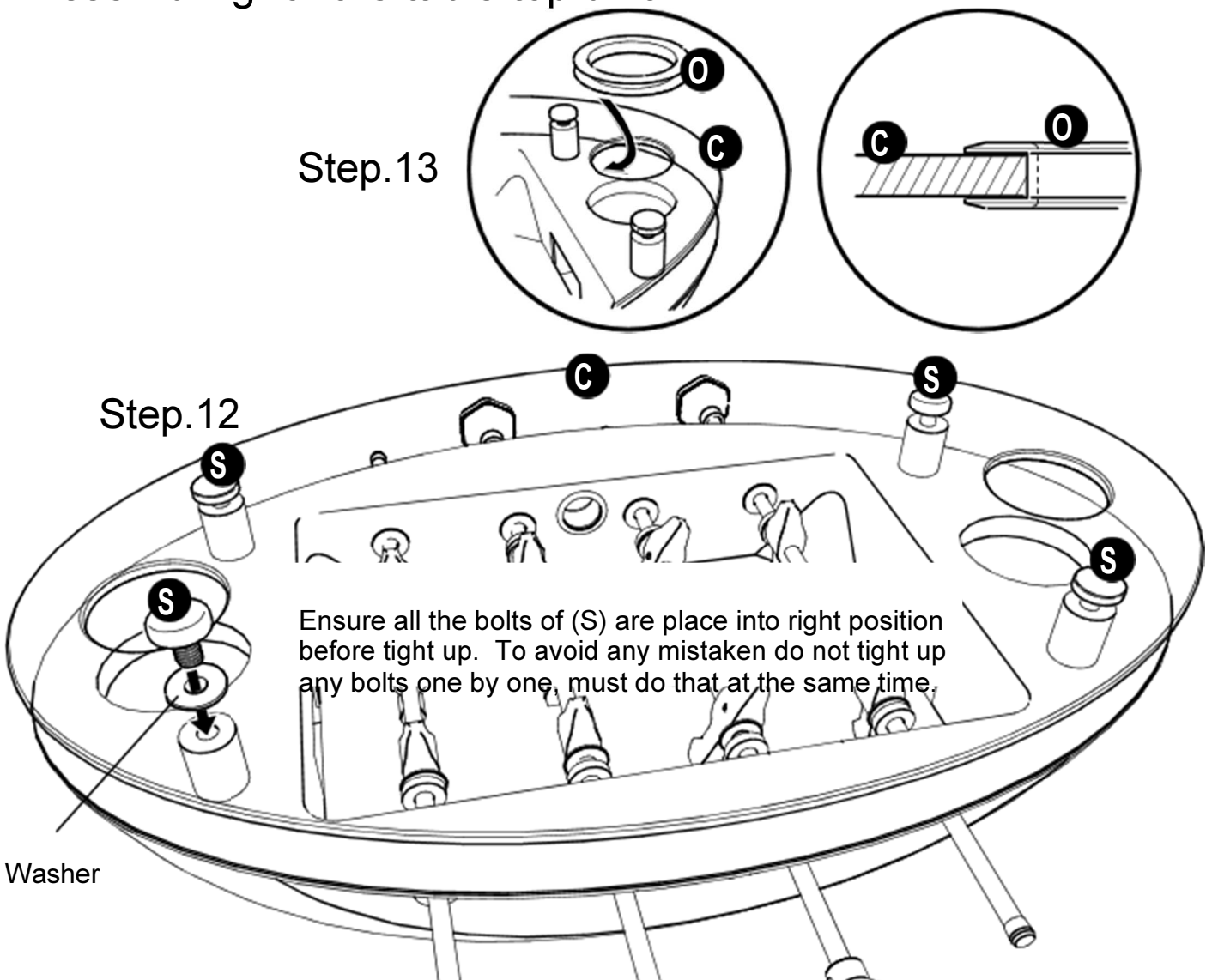

# Combine the table top unit to the base unit

Step.14

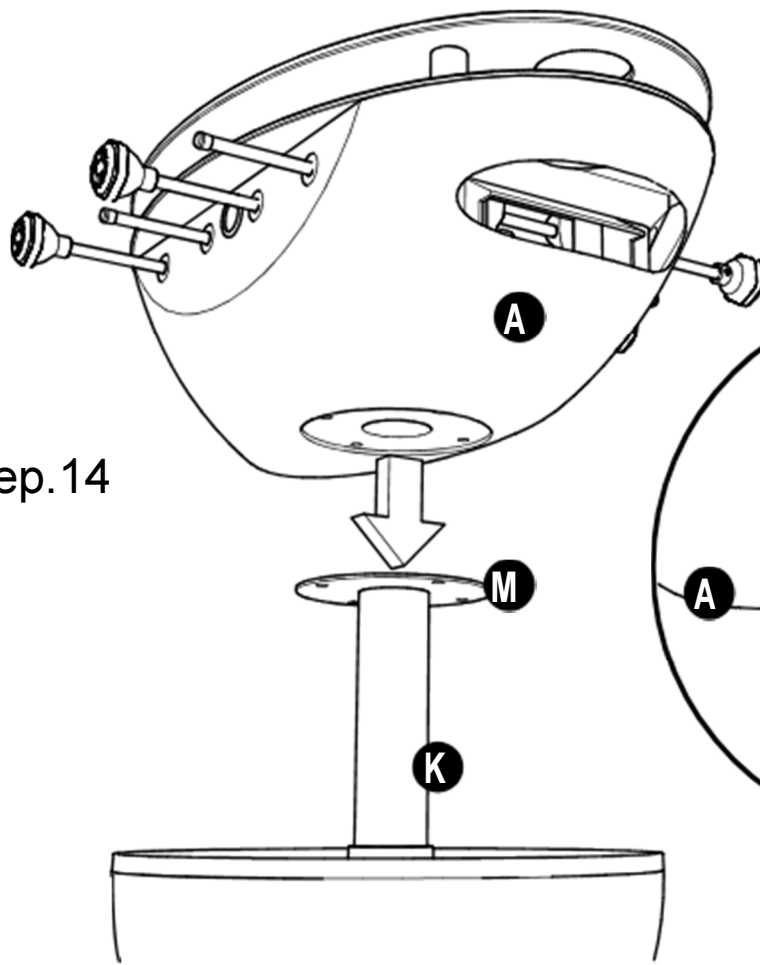

Step.15

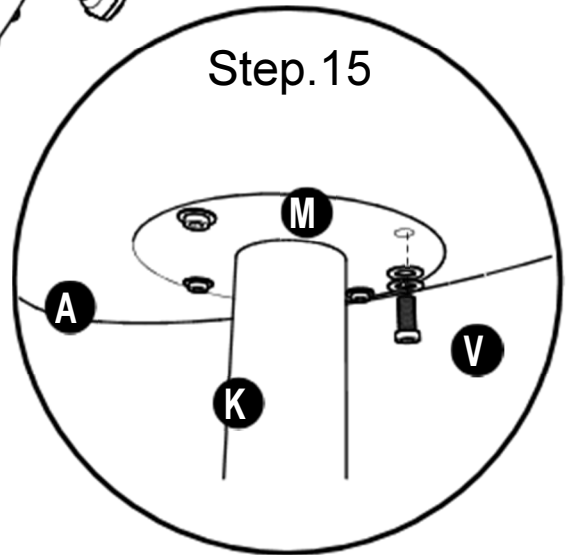

Step.16

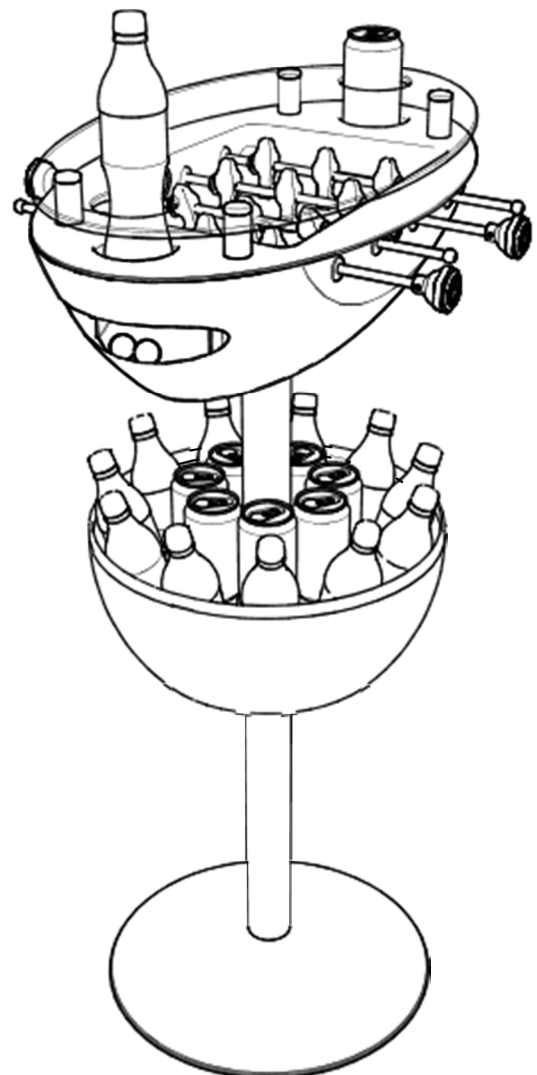
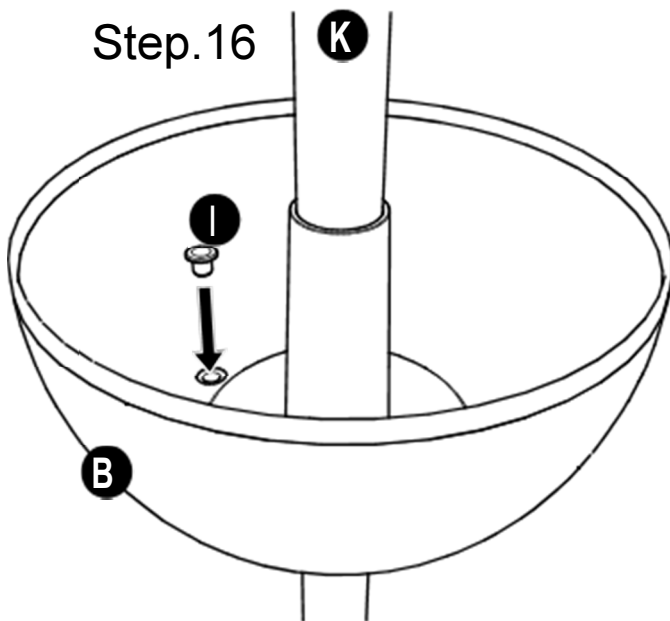

Before put any drinks, ice or water, please insert the end cap ( I ) into the ice bucket ( B ) as shown.